



**MEDIUM DUTY TF35.7 - TF33.9**

Merlo's factories in San Defendente di Cervasca (Cuneo) cover an area of 300,000 m<sup>2</sup> (with 220,000 m<sup>2</sup> indoor facilities)



1. Merlo SpA main offices
2. Final assembly lines
3. Lines for assembling components and cabs
4. Moulding of technopolymers
5. Automated storing and shipping centre
6. Machines plus attachments shipping centre
7. Final quality control
8. Technological centre
9. Steel and structural assembly lines centre
10. 3M attachments
11. CFRM (Training & Research Centre)

# The Merlo Group

## N° 1 for technology and safety

The Merlo brand has always been synonymous with advanced technology in the telehandler field and our history, since 1964, is hallmarked by experience based on determination and passion. The development of complex products, from the idea to the result, from design to sales, means being able to propose orientations for the most competitive markets. The outcome of our efforts are compact, easy to handle telehandlers ensuring incomparable operating performance, comfort, efficiency and safety. At Agritechnica 2013, three important awards were received that clearly demonstrate the technological and innovative superiority of our products:

- Turbofarmer 42.7 Hybrid: Gold Medal for innovation at Agritechnica.
- Turbofarmer II: Machine of the year 2014 in the “handling and logistics” category.
- Multifarmer: Selected as a “milestone” in agriculture.

The new modular Medium Duty and Compact Turbofarmer range was named «Machine of the Year» 2015 at Sima 2015 in the handling and logistics sector.

- 1,200 employees
- Surface area of 300,000 m<sup>2</sup> of which 220,000 m<sup>2</sup> are indoors
- 90% exports
- 600 dealers all over the world
- 8% of turnover invested in Research & Development
- 60 manufacturing robots



Automated boom bending workstation



Roto robotised welding of the chassis

Merlo presents  
the Medium  
Duty range



# Merlo Medium Duty range

## Technology and productivity for all

We were the first to launch a range of telehandlers dedicated to agriculture in 1996. Today, we proudly present the Medium Duty generation developed on the strength of experience acquired in 50 years of operations.

- + **Safety**
  - ✓ Cab compliant with ROPS and FOPS level II standards\*
  - ✓ Approval agricultural tractor (optional)
- + **Comfort**
  - ✓ Largest cab in the standard category
  - ✓ Version equipped with suspended cab (CS), unique and patented solution (dedicated versions)
  - ✓ Reverse shuttle on Joystick, duplicated on steering column
- + **Efficiency**
  - ✓ 18% consumption with standard Eco Power drive (EPD)
  - ✓ Load Sensing (LS) Pump and electronic joystick and boom acceleration
  - ✓ Fan-drive fan as standard. Radiant pack always clean and efficient
- + **Performance**
  - ✓ 2 Engines: 75 HP and 115 HP
  - ✓ Speed 40 km/h as standard on the entire range

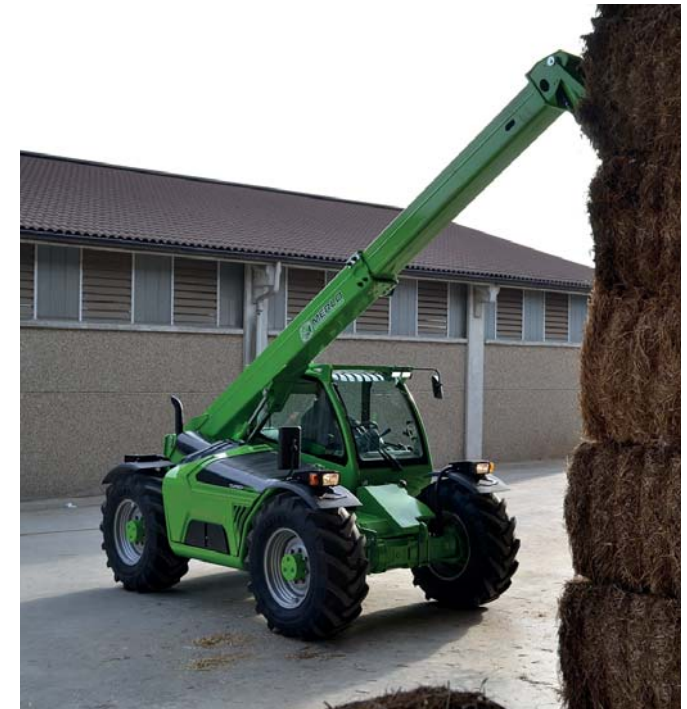

- New cab, the widest in the category
- CS version with suspended cab
- 40 km/h as standard
- EPD as standard -18% of consumption

\* EN ISO 3449/2008, protection level II (highest protection level provided by the norm and equivalent to the fall of a 227 kg object from 5.22 metres)

# Medium Duty family

## Flagship technology and performance



**Innovative Merlo systems**

- Tac-Lock rapid coupling of the attachments

**Lifting capacity**

- Booms from 7 to 9 metres
- Capacities ranging from 3.3 to 3.5 tons

**Safety**

- Merlo Dynamic Control light version
- Cab compliant with FOPS/ROPS

**Versatility**

- Towing hook
- Hydraulic connections (2 opt.)
- Trailer braking (Pneu/Hydr.)

**Comfort**

- Largest cab on the market 1010 mm
- Standard cab on silent-block
- Unique CS version with suspended cab
- Reverse shuttle on Joystick, duplicated on steering column

**Hydraulic system options**

- Gear pump (G) and electro-hydraulic joystick
- Load-Sensing (LS) pump with electronic joystick and automatic accelerator

**Efficiency – Powertrain**

- Engines 75 HP Tier 4 Interim and 115 HP Tier 4 Final
- Merlo 2-speed hydrostatic transmission
- EPD - Eco Power Drive as standard on 115 HP models

# The high performance Medium Duty range

## Two models, 8 evolved versions



MODEL	CAB									
	SUSPENSION		FINISHING		ENGINE		EPD		SAFETY	
	Steady	Suspended - CS	STANDARD	PREMIUM	75 HP Tier 4 Interim Euro IIIB	115 HP Tier 4 Final Euro IV	EPD	EPD TOP	CDC Light	CDC Display
TF35.7	TF 35.7 G	●		●	○	●				
	TF 35.7 - 115 G	●		●	○		●			
	TF 35.7 -115	●		●	○			●	●	○
	TF 35.7 -115 CS		●	●	○			●	●	○
TF33.9	TF 33.9 G	●		●	○	●				
	TF 33.9 -115 G	●		●	○		●			
	TF 33.9 -115	●		●	○			●	●	○
	TF 33.9 -115 CS		●	●	○			●	●	○

● As standard. ○ On request.

### *Broad product offering:*

- Available in 2 models and 8 different versions
- 2 boom lengths - 7 and 9 m
- 2 capacities - 3.3 and 3.5 tons
- 2 engines available - 75 HP Tier 4 Interim/Euro IIIB and 115 HP Tier 4 Final/Euro IV



**Fan Drive available on the entire range.  
Radiators always clean**



# Engines & Transmissions

## Higher performance and lower consumption

- ✓ The Turbofarmer range is equipped with two different engines: a Tier 4 Final 85 kW/115 HP 3.6 litres at 2300 rpm and a Tier 4 Interim 55,4 kW/75 HP 2.9 litres at 2600 rpm
- ✓ Hydrostatic transmissions: two speeds and 40 km/h as maximum speed
- ✓ Merlo's hydrostatic transmissions have an oil circuit that is completely independent of the boom's oil circuit resulting in assuring maximum performance and longer oil's life
- ✓ Fan Drive **1** is a standard feature that allows you to change the rotation direction of the fan, from suction to blowing
- ✓ Models with 115 HP and G pump have Eco Power Drive (EPD) is a standard feature that automatically controls the engine speed when driving, according to operating conditions.
- ✓ Models with 115 HP and LS pump have the EPD Top system, which adds Heavy Load Eco **2** and Speed Control **3** modes capabilities and the automated control of the diesel revs according to the movement of the joystick. The greater the inclination given to the joystick, the higher the rpm of the engine
- ✓ Speed control mode allows the forward speed of the machine to be memorized and to keep it constant (ideal for yard handling operations or road transport)
- ✓ The rpm selector **4** allows the operator either to set minimum engine speed to be kept (selector in position **A**) or to set a maximum engine speed while operating the joystick in proportional inclination mode (selector in position **B**)



- Tier 4 55,4 kW/75 HP or 85 kW/115 HP engine
- 40 km/h unique in the category
- Fan Drive as standard to ensure the radiators are always clean
- EPD system (115 HP): consumption is reduced by 18% compared to traditional technologies
- EPD Top (LS models) guarantees boom responsiveness while keeping consumption to a minimum



4

## Standard cab Largest cab in the category

1. Joystick with reverse shuttle (duplicated on steering wheel); ergonomic and easy to use.
2. Effective heating/cooling ventilation system.
3. Inching-Control: expanded sensitivity for creep movements.
4. Curved windscreen: maximum visibility and safety in work at height.
5. Merlo CDC Light.
6. Glovebox.

5

2

2

6

1

3

# Comfort record

## World exclusive cab with suspensions

[Pressurized  
cab\*]

The new cab was developed to ensure record-breaking comfort for our users.

At 1010 mm, it is the largest in its category, yet even acoustic and thermal comfort involved detailed design; the cab is also pressurised\* to prevent dust entering the cockpit.

The air flow has been specially designed for being distributed evenly inside the driver's cab and reach all areas in an optimal manner. The optional air conditioning system is completely new and was developed based on automotive standards, halving the warm-up and cool-down times, guaranteeing an optimal temperature in all conditions. The new Merlo cab can now reach an internal temperature of 22°C with an external temperature of 43 °C and full sunlight and an internal temperature of 26°C with an external condition of -15 °C and no solar irradiation.

The inlet vent is located on the side of the cab away from potential sources of dust and dirt.

Moreover, it is also available a suspended cab, something only Merlo offers in the field of telehandlers: the pneumatic suspensions provide the best comfort in its class.

### AIR FLOW VENTILATION SYSTEM

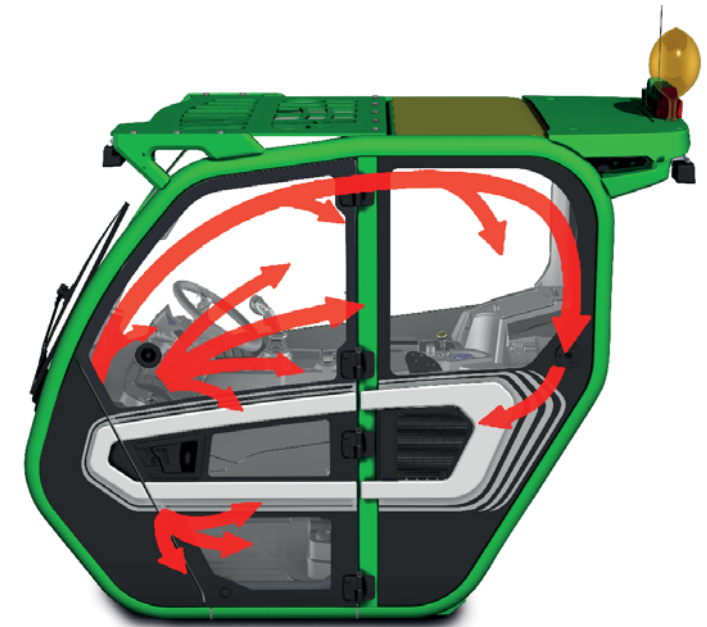

- 1010 mm wide. The cab is the largest in its category
- 4 versions equipped with CS suspended cab
- - 3 dB of interior noise; sound levels halved in comparison with the previous generation of machines



**CS** hydropneumatic suspended cab which can be activated by the operator. The only one of its kind on the market.



**BSS** hydropneumatic suspension of the boom (optional), which can be activated by the operator, automatically deactivates under 3 km/h to ensure maximum precision in the positioning of the loads.



Pneumatic seat for improved comfort.

\* According to the ISO 10263-3 standard, not approved for pesticides.



## Premium cab

Feel like  
in your car

The standard cab and the Premium cab are dimensionally identical and both compliant with the highest safety specifications ROPS and FOPS (level II). The Premium cab it is a perfect match for customers looking for automotive interior cab finishing. In fact it fits all uprights covered by finishing, new designed steering wheel and roof sun-blind. Air condition and five automatic ventilation flows selection are available as an optional in all models. Merlo CDC display, joystick type and EPD control type are features that enrich the product content of the Turbofarmer range and can be standard or optional depending on specific model configuration chosen. Moreover in the Premium cab the outside rear top spoiler (that eventually lodge the air conditioning system) matches colorwise Merlo's green. Please ask your local dealer for more details.

# CDC - Merlo's Dynamic Load Control

## Maximum versatility on LS models



The Merlo Group considers safety as an absolutely essential value, all Merlo models meet the most strict regulation. LS models are featured by the M CDC system to allow every operator to work in total safety by fully exploiting the potential of the telehandler and the equipment used. The operator can check at any time the dynamic stability of the vehicle, thanks to the dot **3** on the screen in the M CDC Display (optional) or the traffic light on the front upright in the M CDC Light version.

For manoeuvres that may give rise to a telehandler stability risk, the M CDC system will block the boom and prevent any further movements that may worsen the situation.



The traffic light indicator on the right side pillar provides a fast and clear information about the machine's stability.



## CDC Display\*

All the safety information is clearly shown in the colour awesome 8.5" display. An indicator on the load chart informs the operator about the dynamic stability of the telehandler and the M CDC avoids risks for the longitudinal equilibrium of the balance by blocking boom movement if needed.

- |  |                                |
|--|--------------------------------|
| <b>1.</b> Equipment in use   | <b>4.</b> Load detection menu  |
| <b>2.</b> Boom work area   | <b>5.</b> Operating parameters |
| <b>3.</b> Current boom-load positioning (represented with a colored dot) | <b>6.</b> Work information     |
|  | <b>7.</b> Stability index      |

\* A Merlo unique feature available as an option in LS models.

**New Medium Duty - the best  
ground clearance**

**405 mm  
of clearance  
380/70-24  
tyres**



# Merlo planetary axles

## Designed for maximum performance and long duration

Our Medium Duty telehandlers are equipped with a new generation of planetary axles that have been conceived, designed and constructed in-house. The solution with planetary reducers was chosen to keep the machine's height as high as possible.

The axles consist of a central cast iron body, planetary reducers and differential locking. Braking is ensured by 4 dry disc brakes keyed onto the axle shafts, allowing a remarkable reduction in friction and, consequently, consumption.

To complete the specifications offered, the Medium Duty telehandlers are equipped with a parking disc brake which is automatically engaged when the diesel engine is switched off, or engaged directly by the operator in the event of work on sloping surfaces.

The new axles ensure an excellent ground clearance of 380 mm (405/70-24 tyres), making it possible to pass obstacles with agility.



### THREE STEERING MODES



FRONT WHEEL STEERING MODE



FOUR WHEEL STEERING



CRAB STEERING



The manual parking brake selector is automatically engaged when the engine is switched off.

- Axles conceived, designed and produced in-house by Merlo
- Compact solution to maintain a reduced height in all the versions
- 380 mm ground clearance
- Three steering modes
- Dry brakes to reduce friction and consumption while ensuring 40 km/h
- Automatic engaging of the parking brake when the engine is switched off

Boom handling: speed and precision





# Merlo precision and technology

## An effective and cutting-edge boom

Merlo produces the booms mounted on its telehandlers in-house and has developed unique technologies to make them strong yet lightweight, protect handling mechanisms against accidental blows and allow users to position the load in the most precise manner possible.

- ✓ Boom sheet metal welded on the boom's neutral bending axis
- ✓ Cartridge protected handling system inside the boom, thanks to a patented solution that is easy to access if maintenance is needed
- ✓ Tac-Lock: hydraulic attachment clamping system from the cab

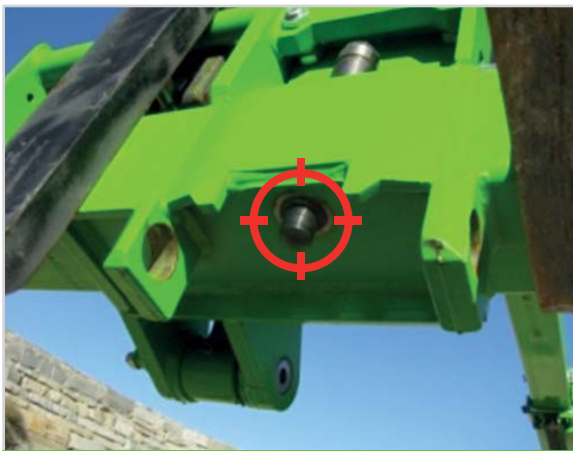

Tac-Lock: hydraulic attachment clamping system from the cab



Pipes, power cables and auxiliary hydraulic are all located inside the boom

- Lighter but stronger booms: robotised welding on the neutral axis, area with less strain
- Extension mechanism well-protected inside the boom
- Carriage equipped with Tac-Lock hydraulic locking

Merlo attachments,  
many solutions in a single handler



# Developing multi-purpose solutions

## More efficiency and productivity thanks to Merlo design

Merlo adopts simple and effective guidelines in the evolution of its products. From conception to development, everything is studied, designed and created in the Group's research centre. This simple "rule" also applies to attachments. Backed by years of experience, Merlo's engineers have developed a wide range of attachments, divided by type and load capacity. This way of working makes possible to offer a wide portfolio of well tested and interchangeable equipment that save time and fatigue.



BALE FORKS



MANURE FORK WITH CLAW

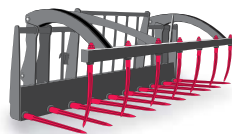

GRIPPERS FOR BALES

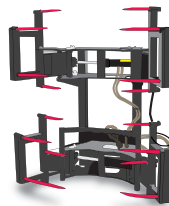

MULTI-PURPOSE LOADER WITH CLAW

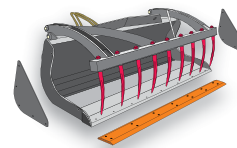

LOADERS

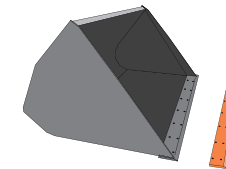

GRIPPERS FOR WRAPPED BALES

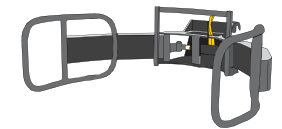

HOOKS/LIFTING BOOMS



CARRIAGE-MOUNTED HOOK



FLY JIB

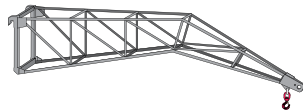

PLATFORMS



WINCH

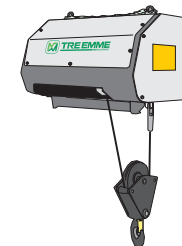

DIGGING BUCKET

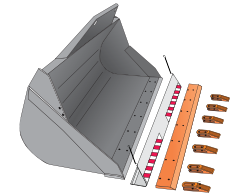

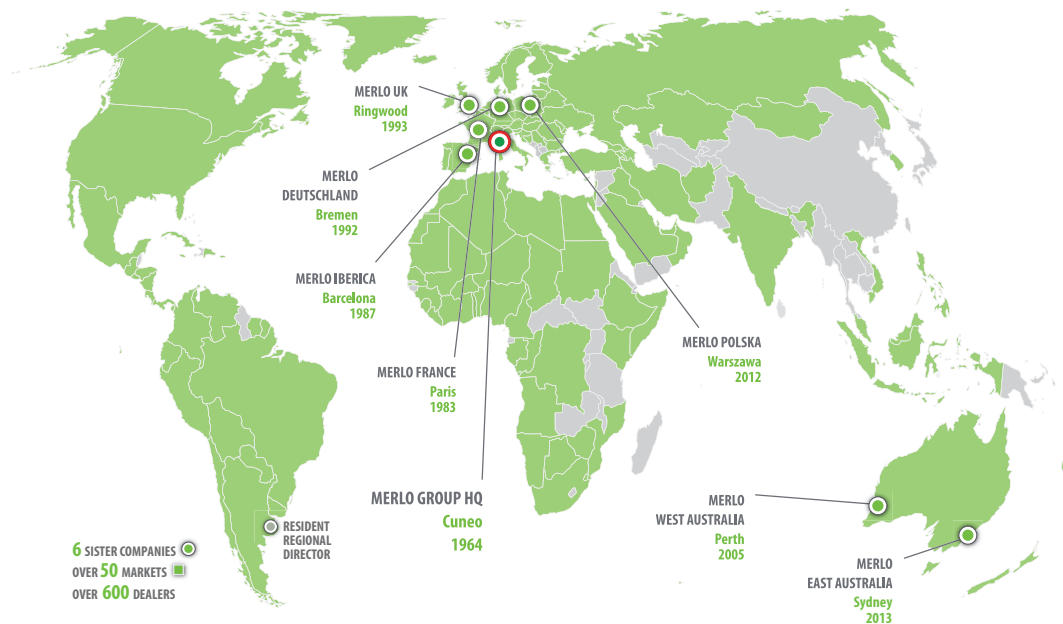

### TRAINING CENTRE

The Merlo Training and Research Centre (CFRM) has made safety training and instruction in the use of the machine its mission. The CFRM provides training courses for operators of person-carrying overhead platforms, forklift trucks, telehandlers, cranes, earth-moving machinery, agricultural and forestry tractors, snow ploughs and urban cleaning vehicles.



### Countries where Merlo is a market leader



### MOVIMATICA MERLO INFOMOBILITY

Is the new system, conceived and built within the Merlo Group, for managing vehicles remotely: it enables GPS radio-localisation in real time, monitoring operation and use, receive and manage malfunction or burglar alarms and also send commands for handling events via the internet.



# THE MERLO WORLD

## In a globalised world, **the customer always comes first!**

From excellent products to excellent service. In 2008, Merlo has adapted its production process to meet the needs of the ISO 9001 quality control system. The process is perfected and improved continuously.

At the same time, the foundations have been laid to put the Customer first, implementing investments aimed at Services such as Financing, Aftersales training, Spare parts and Telematic Means such as remote diagnostics, thanks to the Merlo Mobility project.

Automatic spare parts warehouse	2011	2016
Storage volume	1000 m <sup>3</sup>	13000 m <sup>3</sup>
Filling	100%	85%
Percentage of codes managed	50%	86%
Percentage of order lines managed	65%	94%
Pick-up time	90"	30"
Number of codes	8000	18000

### NEW PARTS CENTRE

The new spare parts warehouse covers an area of 7,000 m<sup>2</sup>, with storage capacity for of 10,000 m<sup>3</sup> for a total of 20,000 different codes. Furthermore, it can automatically manage 94% of the order lines that are processed daily, with an average withdrawal time of 30" per line.

The first fill per order line is over 99% with delivery times for urgent orders within 24 hours.

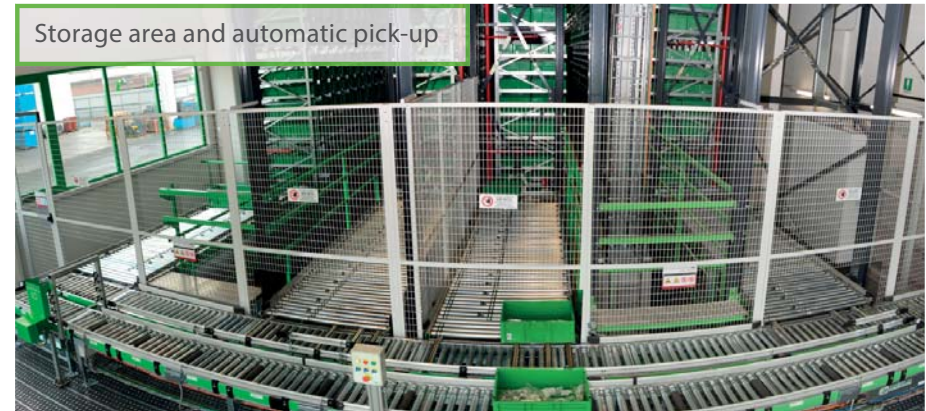

Order processing and shipment area

TECHNICAL INFORMATION	TF 35.7 G	TF 35.7 - 115	TF 35.7 - 115 CS	TF 35.7 - 115 G	TF 33.9 G	TF 33.9 - 115	TF 33.9 - 115 CS	TF 33.9 - 115 G
Total unladen mass, without forks (kg)	6650	6650	6800	6650	6950	6950	7100	6950
Maximum capacity (kg)	3500	3500	3500	3500	3300	3300	3300	3300
Lifting height (m)	6,6	6,6	6,6	6,6	8,6	8,6	8,6	8,6
Maximum reach (m)	3,5	3,5	3,5	3,5	5,7	5,7	5,7	5,7
Maximum operating height (m)	6,6	6,6	6,6	6,6	6,2	6,2	6,2	6,2
Maximum operating reach (m)	1,3	1,3	1,3	1,3	1,5	1,5	1,5	1,5
Capacity at maximum height (kg)	3500	3500	3500	3500	1750	1750	1750	1750
Capacity at maximum reach (kg)	1350	1350	1350	1350	600	600	600	600
Turbo motor (displacement/cylinders)	2,9/4	3,6/4	3,6/4	3,6/4	2,9/4	3,6/4	3,6/4	3,6/4
Tier 4 motor power (kW/CV)	55,4/75	85/115	85/115	85/115	55,4/75	85/115	85/115	85/115
Maximum speed (km/h)	40	40	40	40	40	40	40	40
BSS hydro-pneumatic boom suspension	○	○	○	○	○	○	○	○
Fuel tank (l)	100	100	100	100	100	100	100	100
G - Hydraulic gear pump (bar-l/min)	210/98	-	-	210/98	210/98	-	-	210/98
LS - Hydraulic Load-Sensing pump (bar-l/min)	-	210/125	210/125	-	-	210/125	210/125	-
Fan Drive Pump (l/min)	36	46	46	46	36	46	46	46
Flow Sharing Distributor	-	●	●	-	-	●	●	-
Hydraulic oil tank (l)	85	85	85	85	85	85	85	85
FOPS (ISO 3449) and ROPS (ISO 3471) cab	●	●	●	●	●	●	●	●
Electrohydraulic joystick	●	-	-	●	●	-	-	●
Electronic joystick	-	●	●	-	-	●	●	-
Hydrostatic transmission	●	●	●	●	●	●	●	●
Differential lock (A-P)	○	○	○	○	○	○	○	○
Dual Control Reverse Shuttle (joystick/steering wheel)	●	●	●	●	●	●	●	●
Inching Control progress control from pedal	●	●	●	●	●	●	●	●
Permanent four-wheel drive	●	●	●	●	●	●	●	●
Four-wheel steering	●	●	●	●	●	●	●	●
Automatic parking brake (when the engine switches off)	●	●	●	●	●	●	●	●
Work headlights on cab (2 A + 2 P)	○	●	●	○	○	●	●	○
LED work headlights on cab	○	○	○	○	○	○	○	○
Gearbox	2 speeds	2 speeds	2 speeds	2 speeds	2 speeds	2 speeds	2 speeds	2 speeds
CS - Suspended cab	-	-	●	-	-	-	●	-
EPD - Eco Power Drive	-	●	●	●	-	●	●	●
Dynamic Load Control M CDC LIGHT*	-	●	●	-	-	●	●	-
Standard tyres	405/70-24	405/70-24	405/70-24	405/70-24	405/70-24	405/70-24	405/70-24	405/70-24
Type approval as an agricultural tractor	○	○	○	○	○	○	○	○

\*Merlo CDC Display and Premium cab available as an option.

● As standard. ○ On request.

# TECHNICAL INFORMATION

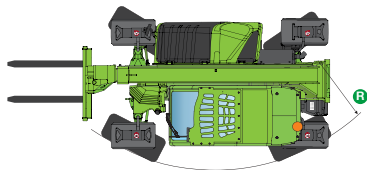
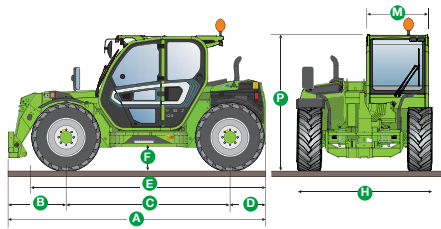

DIMENSIONS	TF35.7	TF33.9
A (mm)	4310	4330
B (mm)	970	990
C (mm)	2740	2740
D (mm)	600	600
E (mm)	3910	3910
F (mm)	380	380
H (mm)	2250	2250
M (mm)	1010	1010
P (mm)	2240/2300*	2240/2300*
R (mm)	4095	4095

\*CS activated

## TF 35.7 WITH FORKS

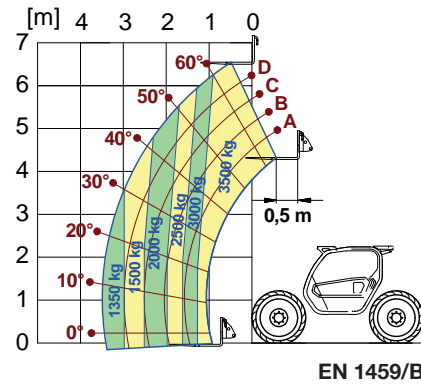

## TF 33.9 WITH FORKS

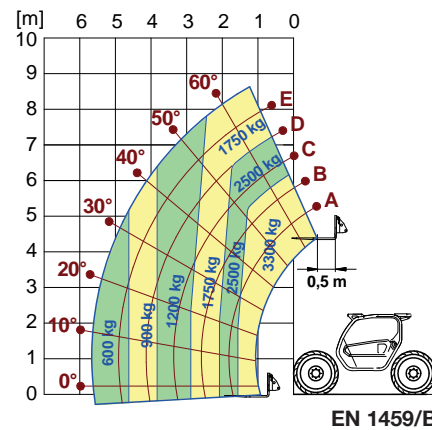

# Towing hooks and trailer braking systems (option)

## Maximum versatility and productivity

The new Turbofarmer Medium Duty range can be equipped with **towing hook** and pneumatic or hydraulic trailer braking system for maximum versatility, productivity and safety.



## OVER 50 YEARS OF CONSTANT COMMITMENT TO WORKING TOGETHER WITH YOU

- 1964** - Establishment of the Merlo Group
- 1966** - DM and DBM: the first dumper and the first self-loading concrete mixer
- 1981** - SM: the world's first telescopic handler
- 1987** - Panoramic: the world's first telehandler with side engine
- 1991** - Roto: the world's first telehandler with rotating turret
- 1996** - Turbofarmer: the first telehandler in Europe type-approved as an agricultural tractor
- 1998** - P20.6: the ultra-compact telehandlers
- 2000** - Multifarmer: the first agricultural tractor with telescopic boom
- 2001** - MM: the first forestry attachment-carrier
- 2010** - Hybrid: the first diesel/electric hybrid telehandler
- 2012** - Modular: a new concept of telescopic handler
- 2013** - Three important awards at the Agritechnica in Hanover:
  - Hybrid 42.7: gold medal for technological innovation
  - Turbofarmer II range: "machine of the year 2014"
  - Multifarmer 40.9: "a milestone in agricultural machinery"
- 2015** - New modular Medium Duty and Compact Turbofarmer named "machine of the year" 2015 at Sima in Paris



**MERLO S.P.A.**

Via Nazionale, 9 - 12010 S. Defendente di Cervasca - Cuneo - Italia

Tel. +39 0171 614111 - Fax +39 0171 684101

[www.merlo.com](http://www.merlo.com) - [info@merlo.com](mailto:info@merlo.com)

**MERLO UK LTD**

The Paddocks, Headlands Business Park - Salisbury Road, Ringwood,

Hampshire - BH24 3PB - UK

Tel. 01425 480806 - Fax 01425 477478

[www.merlo.co.uk](http://www.merlo.co.uk) - [info@merlo.co.uk](mailto:info@merlo.co.uk)

*The Telehandlers outlined in this documentation can be equipped with optional or special accessories that are not included in standard equipment but only on request.*

*In certain countries, not all models or attachments may be available because of market or regulatory restrictions.*

*Technical data and information are up-to-date at the time of printing this documentation. Merlo reserves the right to make modifications arising from natural technological evolution without any obligation on its part.*

*Your trusted Merlo Dealer will be delighted to provide you with all updates concerning our products and services.*